



## PPE holder

The attachment that puts personal protection within arms reach.



# The Silentia PPE holder

The Silentia PPE holder gives easy access to hand sanitizer, gloves, wet wipes and other products. It attaches to the Silentia screen and does not require tools.

**PPE holder 1**, compatible with:  
Bed end screen, Folding screen Trolley

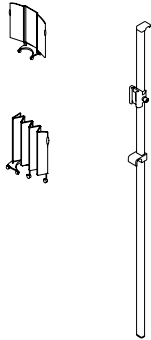

One size fits all

Art.no 06580

**PPE holder 2**, compatible with:  
Folding screen

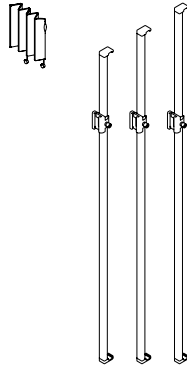

1,45 m 1,65 m 1,85 m

Art.no 06584 Art.no 06585 Art.no 06586

**PPE holder 3**, compatible with:  
Semifix screen, Fixed screen

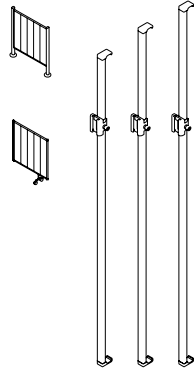

1,45 m 1,65 m 1,85 m

Art.no 06581 Art.no 06582 Art.no 06583

## Installation

No tools required

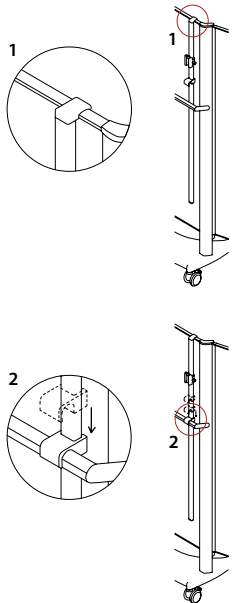

## Installation

No tools required

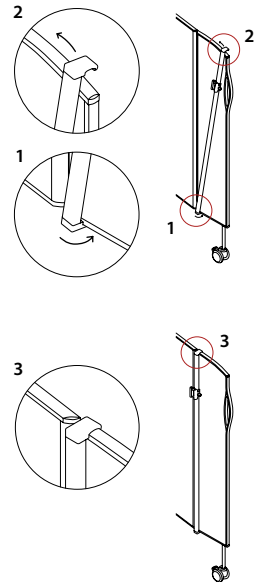

## Installation

No tools required

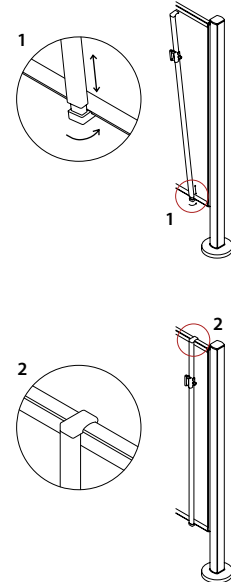

# PPE holder accessories

PPE products are attached to the holder with accessory clamps, making it easy to swap or move products. The clamps can easily slide along the holder to the preferred position.

Inner measurements:  
Depth: 5 mm  
Width: 30 mm

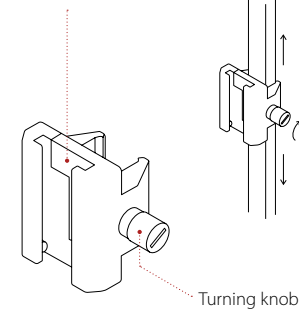

Attachment area for  
PPE products

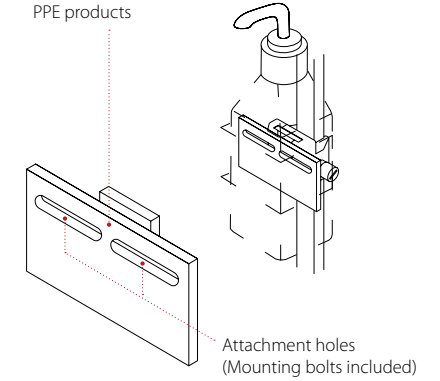

**PPE accessory clamp:** Enables PPE products to be attached to the holder and slide to the desired position.

Art.no 06590

**PPE adapter plate:** Enables any PPE product to be attached to the accessory clamp.

(Requires accessory clamp.)  
Art.no 06592

## PPE holder 1

Max. Load 4 kg

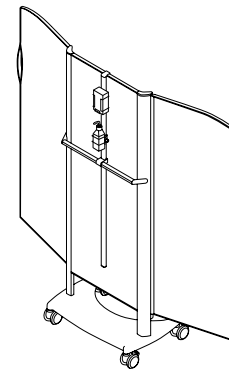

## PPE holder 2

Max. Load 1 kg

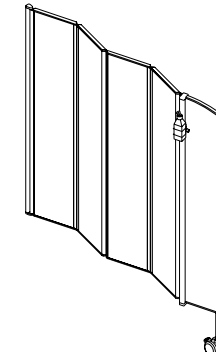

## PPE holder 3

Max. Load 6 kg

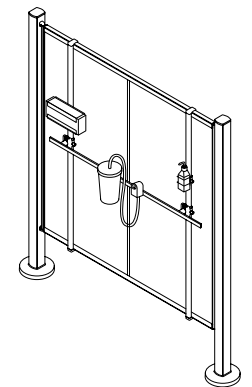

Please contact the Silentia sales team for further information.



Silentia AB, Sweden  
Tel +46 (0)346 485 80  
info@silentia.se



Watch video!

**Keep it Clean™**

Made in Sweden in our factory that runs on 100% renewable energy.

[www.silentia.com](http://www.silentia.com)